

# TX-28LD2P Operating Instruction

---



# Panasonic



## TX-28LD2P

### Quintrix



**TOP  
TEXT**

Please read these instructions completely before use  
and retain them for future reference.

Dear Panasonic Customer,

Welcome to the Panasonic family of customers. We hope that you have many years of enjoyment from your new colour television. This is a very sophisticated TV; the best way to understand the features is to read this book thoroughly, before operating the set.



This television has a low power consumption making it very cost effective to run. To this end, the standby power consumption is merely 1 watt.

## Contents

● Warnings and Precautions .....	2	Station Naming Operation .....	11
● General Information .....	2	Programme Edit Operation .....	11
● Features and Accessories .....	3	● Operation of Controls .....	12
● Battery Installation and Replacement .....	3	● Features Operation .....	15
● Aerial Connection .....	3	● VCR Operation .....	17
● Location of Controls and connection terminals .....	4	● Teletext Operation .....	18
● Layout of On Screen Displays .....	6	● <b>Audio / Video (AV) Connections</b> .....	20
● Mains On / Off .....	7	Via the AV1 / AV2 21 Pin (SCART) .....	20
● <b>Tuning Procedure</b> .....	7	Via the front AV3 Video and Audio (RCA) .....	20
Auto Tuner Presetting .....	7	Via the rear AV2 RCA Audio Out .....	21
Tuning Menu access .....	8	Connection of Stereo Headphones .....	21
Manual tuning operation .....	8	● Trouble—shooting .....	22
Colour System Selection .....	10	● Specifications .....	22
Audio Standard Selection (TV System) .....	10		

## Warnings and Precautions

- This TV set is designed to operate on A.C. 220 – 240V, 50Hz.
- To prevent damage which might result in electric shock or fire, do not expose this TV set to rain or excessive moisture.
- **WARNING : HIGH VOLTAGE !!!**  
Do not remove the rear cover as live parts are accessible when it is removed. There are no user serviceable parts inside.
- Avoid exposing the TV set to direct sunlight and other sources of heat.
- Remove the mains plug from the wall socket when the TV set is not used for a prolonged period of time.
- **CABINET AND PICTURE TUBE CARE**  
Remove the mains plug from the wall socket. The cabinet and picture tube can be cleaned with a soft cloth moistened with mild detergent and water. Do not use solutions containing benzol or petroleum. TV sets can produce static electricity, care must be taken whenever touching the TV screen.
- Adequate ventilation is essential to prevent failure of electrical components, we recommend that a gap of at least 5cm is left all around this television receiver even when it is placed inside a cabinet or between shelves.

## General Information

### Service

Before requesting service, please refer to the trouble—shooting guide on page 22 to determine the symptoms. To obtain service please contact your local Panasonic dealer quoting the model number and serial number (both are located at the rear of the TV).

### TV. Games / Home Computers

Extended use of TV games or home computers with any television set can cause a permanent 'shadow' on the screen. This type of irreversible picture tube damage, can be limited by observing the following points:

- Reduce the brightness and contrast levels to a minimum viewing level.
- Do not operate the television set for a continuous period of time while using TV games or home computers.
- This type of picture tube damage, is not an operating defect, and as such is not covered by the Panasonic warranty.

### Sleep Feature

If the set is not switched off when the TV station stops transmitting at the end of the evening, it will automatically go to standby mode after 30 minutes. This function will not operate when the TV is in AV mode.

### Last Position Memory

Certain functions have a last position memory, i.e. the setting at the time of switch—off will be the setting used when the receiver is switched on again:—

Programme	Tint (M.NTSC / NTSC only)
AV Position	Contrast
Volume	Sharpness
Stereo mode	Aspect
Bass	Standby
Treble	Artificial Intelligence (AI)
Balance	Music / Speech
Colour	Brightness
Status	Volume Correction
OSD Language	Ambience
AV Colour System	

### System Selection

#### Colour System (AUTO / PAL / SECAM)

The correct colour system will be automatically selected if this receiver is in 'AUTO' mode. It may be manually switched using the method detailed on page 10.

## Features and Accessories

- Auto-Setup (ATP)
- Artificial Intelligence
- Stereo Sound System
- TOP Teletext
- On Screen Displays
- AV In / Out (Rear) / AV In (Front)
- S-Video Input
- Multi-function Remote Control (TV / Teletext / VCR (Panasonic))

- 100 Position Tuning System (1 – 99 plus VCR)
- AV NTSC Reception

### Please check and identify the following supplied accessories.

- Remote Control Transmitter (EUR51920)
- Batteries for the Remote Control Transmitter (2 x R6 (UM3) size)

## Battery Installation and Replacement

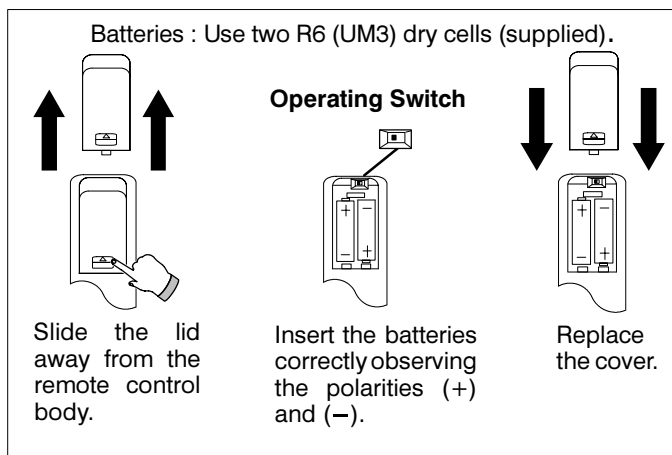

### Operating Switch

If any difficulty is encountered when using this remote control with Panasonic video tape recorders please check the operation of the video recorder with the operating switch set at position one and again with the switch set at position two.

### Precautions

- If experiencing any remote control malfunctions or reduction in operating distance please check and replace batteries and clean indicator window.
- Do not use an old battery with a new one.
- Ensure the batteries are inserted with the correct polarity.
- Do not use rechargeable (Ni-Cad) batteries.
- Do not mix battery types, i.e. Alkaline and Manganese.
- Remove exhausted batteries and dispose of them immediately.

### Please contribute to environmental protection

- Used batteries and rechargeable batteries do not belong in the normal household rubbish.
- Please contact your local community office for information regarding special collection places where you can dispose of the used batteries.
- Please enquire if used batteries, with the recycling symbol, may be handed back to the shop at which they were purchased.

## Aerial Connection

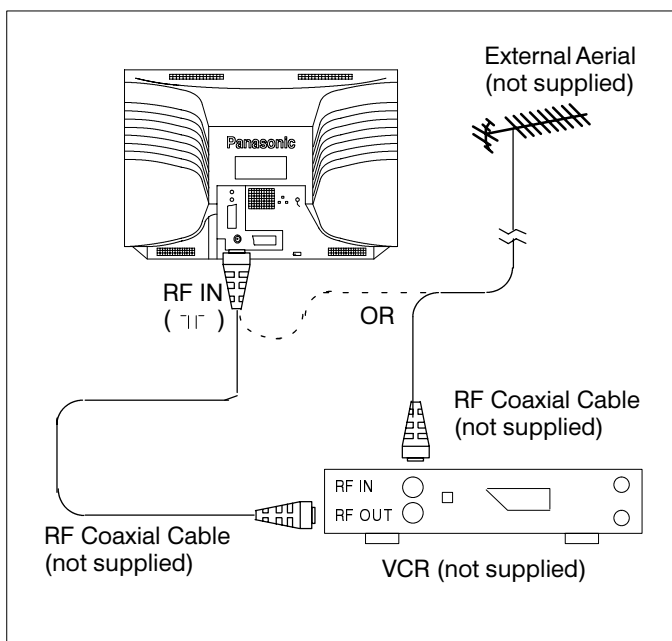

### Aerial connection

Connect your Aerial to the RF IN socket at the rear of the TV.

### Aerial connection via a VCR

If a VCR is to be connected, connect your Aerial to the RF IN socket at the rear of the VCR then connect an RF coaxial cable between the VCR RF OUT socket and the TV RF IN socket.

For information on how to connect a VCR to this TV using Audio / Video cables please refer to page 20.

## Location of Controls and connection terminals

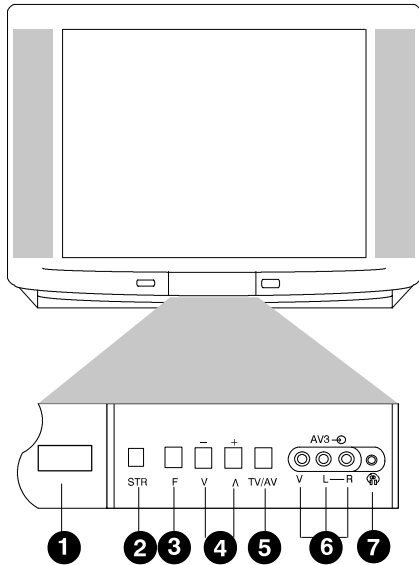

### Remote Control

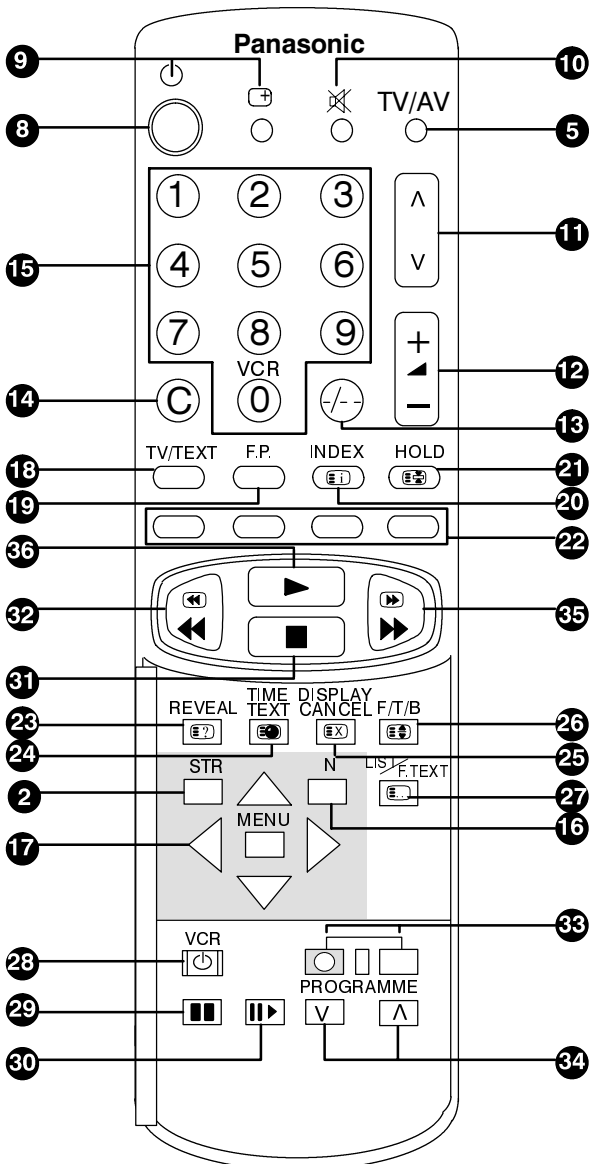

- 1 Mains On / Off**  
Switches the TV on or off.
- 2 Store (STR)**  
Used to store the channel settings in Tuning Mode or to store the normal settings.
- 3 Function Select (F)**  
Displays the On Screen Display functions, use repeatedly to select from the available functions.
- 4**   
Increases or decreases the programme position by one. When a function is already displayed, press to increase or decrease the selected function.
- 5 TV / AV**  
Switches between Television and Audio / Video operation.
- 6 RCA Audio / Video sockets**  
For the connection of Audio / Video equipment e.g. VCR.
- 7 Headphones Terminal**  
For the connection of headphones with a 3.5mm jack plug. the TV speakers will be automatically disconnected when the headphones are connected.
- 8 Standby**  
Press to switch the TV on or off.
- 9 Status**  
Displays the channel number, programme position, time and teletext station name.
- 10 Sound Mute**  
Press to mute or restore the sound.
- 11 Programme Up / Down**  
Increases or decreases the programme position by one.
- 12 + / -**  
Increases or decreases the volume.
- 13 Programme position 10 – 99**  
Selects programme positions from 10 to 99.
- 14 Direct channel access**  
Allows direct access to local channels via the 0 – 9 keys.
- 15 0 – 9 keys**  
Selects programme numbers or teletext pages.
- 16 Normalisation (N)**  
Recalls the levels previously set with the store (STR) key.
- 17 Menu and cursor keys**  
Provides access to the On Screen Display menu system.
- 18 TV / Teletext**  
Switches between Teletext and normal TV operation.
- 19 Favourite Page (F.P.)**  
Press to display the favourite page for the current programme position.
- 20 Index**  
Displays the index page for the current teletext station.

## Location of Controls and connection terminals

- 21 Hold**  
Allows the current page to be held.
- 22 Coloured keys (Red / Green / Yellow / Blue)**  
To enable selection of topics in TOP's / FASTEXT operation and page numbers in LIST operation.
- 23 Reveal**  
Reveals hidden answers to Teletext quizzes.
- 24 Time Text**  
Allows selection of any sub—pages within teletext pages.
- 25 Display Cancel**  
Removes the Teletext page from screen, whilst awaiting an update or newsflash.
- 26 Full / Top / Bottom**  
Switches between the Top, Bottom and Full page display.
- 27 List / F.Text**  
Switches between TOP, FASTEXT and LIST modes.
- 28 VCR Standby**  
Sets the VCR into standby.
- 29 Pause / Still**  
Pauses the picture.
- 30 Still Advance**  
Advances the picture frame by frame in Pause / Still mode.
- 31 Stop**  
Stops the tape.
- 32 Rewind / Review**  
Rewind the tape or review when in play mode.
- 33 Record**  
Press to record.
- 34 VCR Programme up / down**  
Changes programme position by one.
- 35 Fast Forward / Cue**  
Forward the tape or cue the picture.
- 36 Play**  
Playback the tape.
- 37 Mains Plug**  
The mains connection is made with this plug (220 – 240V, 50Hz).
- 38 Aerial Socket (RF IN)**  
The aerial connects to this socket.
- 39 RCA Audio Out terminals**  
For connection to external audio equipment, enabling the sound to be heard through the audio equipments speakers.
- 40 21 pin SCART terminals**  
For the connection of VCRs and other equipment with a SCART terminal.

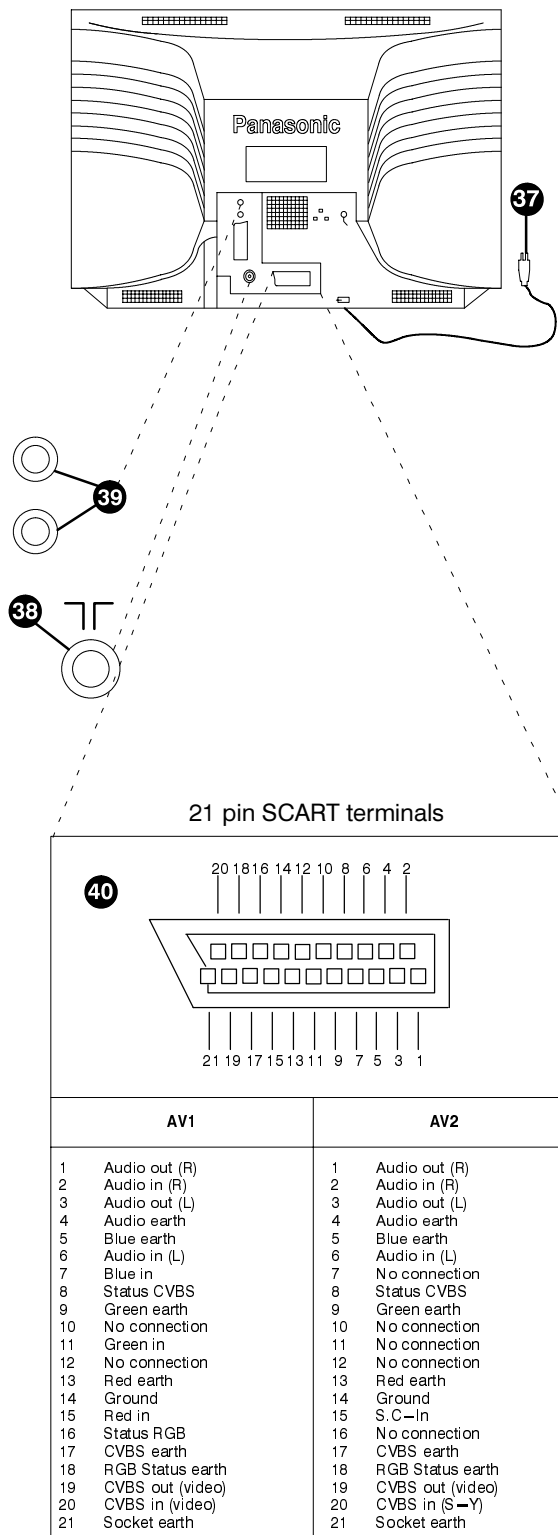

# Layout of On Screen Displays

The main functions of this television receiver are set up using on-screen menus, which are contained in the menu structure starting from the Main menu as shown below.

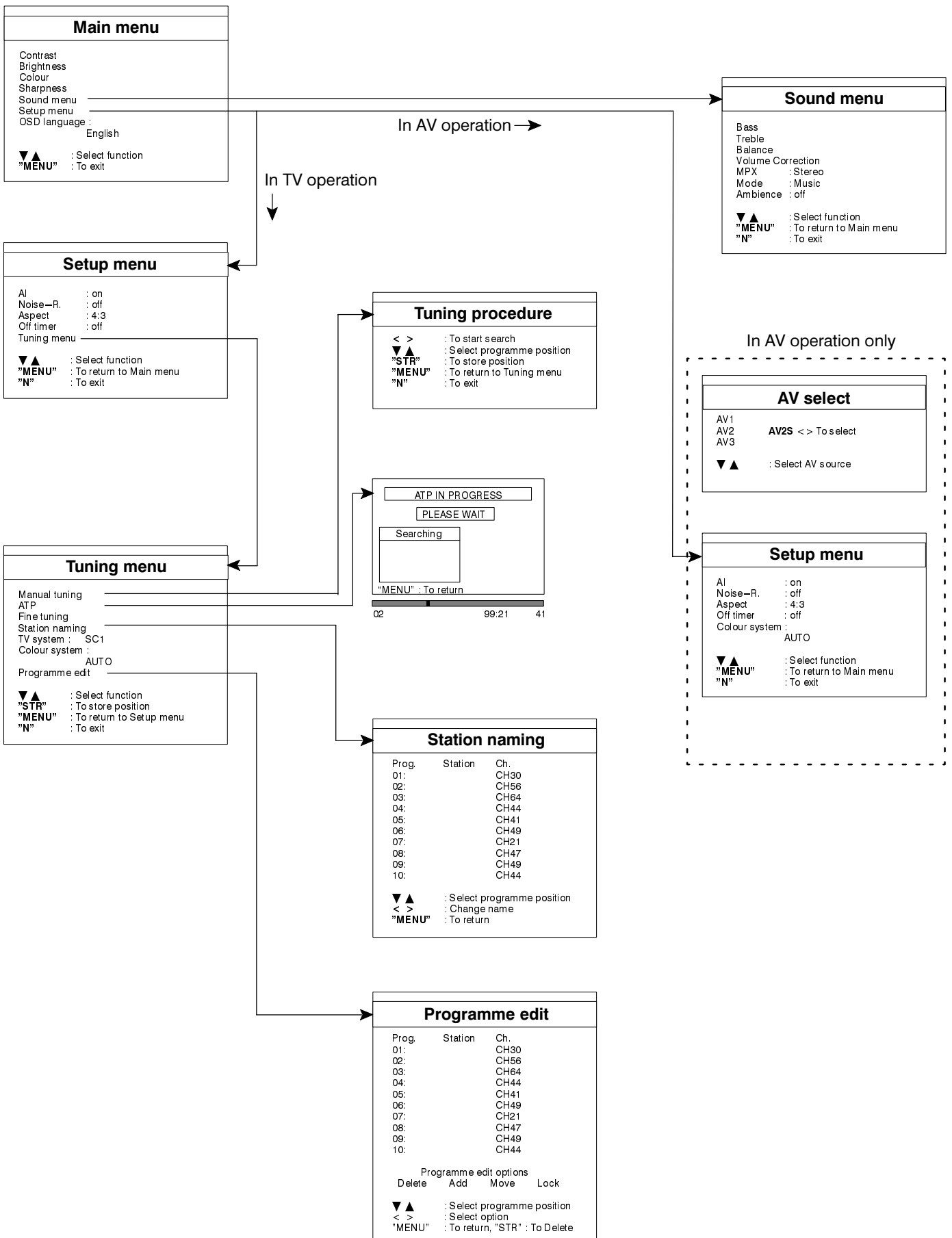

## Mains On / Off

To switch ON press the Power on / off button situated on the front of the TV.

If the power to this TV is interrupted whilst it is switched on, when power is returned the TV will automatically switch back on.

To switch OFF press the Power On / Off button again.

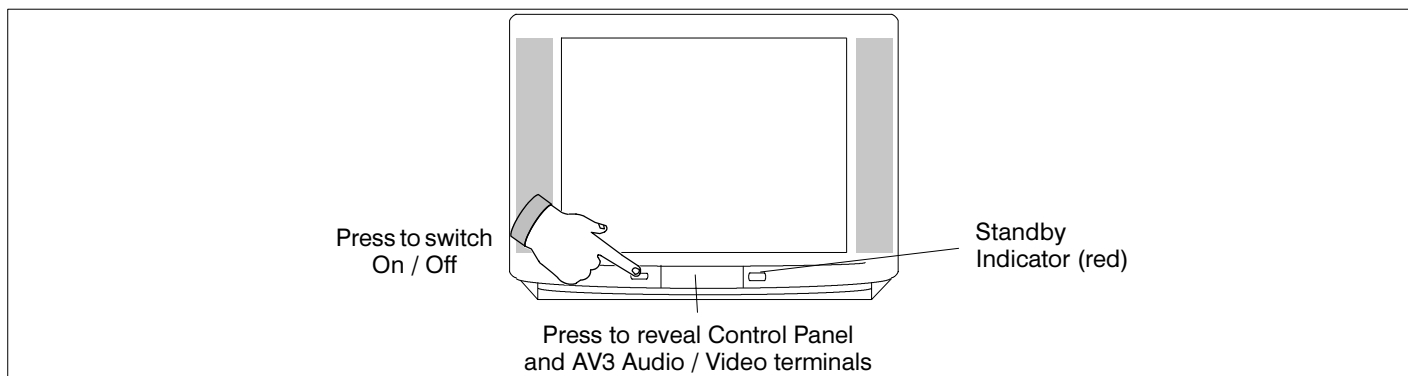

## Tuning Procedure

This TV is capable of receiving the following transmission standards : PAL B, G, H, D, K, PAL-60, SECAM B, G, D, K and M-NTSC. When first switched on, the “ ATP ” menu is displayed, just select the required language and country to proceed.

### Auto Tuner Presetting ( ATP )

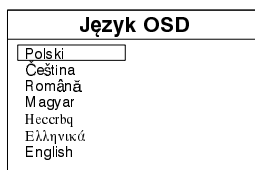
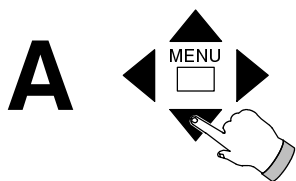

Before starting check that the aerial is connected.

Press ▼▲ to select desired language.

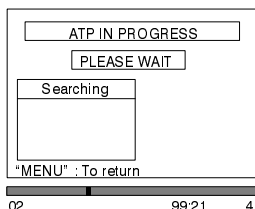
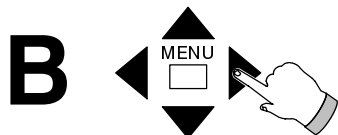

Press ◀▶ to proceed.

This searches for the channels, storing them when found and adding the channel name.

When all available channels have been stored, they are sorted into order and allocated programme position numbers.

To stop “ATP” at any time press **MENU**.

**C**



The TV will display the currently selected channel.

- When ATP is in progress, the colour system is preset to AUTO, this means that when a PAL, SECAM or M-NTSC transmission is received the correct picture will automatically be displayed on screen.
- To activate ATP again, first perform Tuning menu access (refer to page 8), selecting ATP when in the Tuning menu will return you to Step B of ATP operation detailed above.
- The sorting order depends on the TV signal, the broadcast system and reception conditions. if the order is not to your preference it can be re-arranged using the programme edit feature as explained on page 11.



# Tuning Procedure

## Tuning Menu access

The tuning menu allows access to re-tune, rename or reorder programmes and also alter their stored standards. To access the tuning menu proceed as follows :

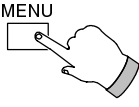
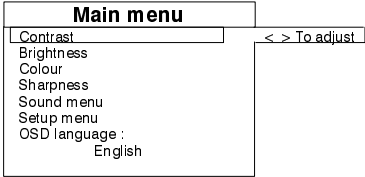
**A**  

Press **MENU**.  
The screen will display the main menu.

---

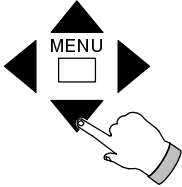
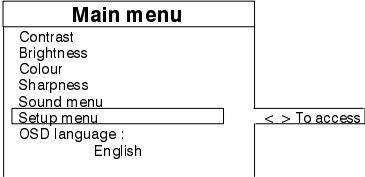
**B**  

Press **▼▲** to move to "Setup menu".  
Press **◀▶** to access "Setup menu".

---

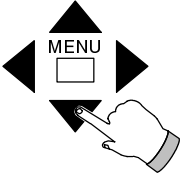
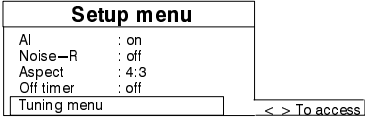
**C**  

Press **▼▲** to move to "Tuning menu".  
Press **◀▶** to access "Tuning menu".

## Manual tuning operation

The desired channels can be manually stored using the following method, if the Colour system and Audio system selected are not correct it will be necessary to set them manually as explained in the Colour System and Audio Standard sections following manual tuning.

### Remote Control Operation

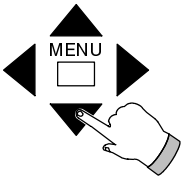
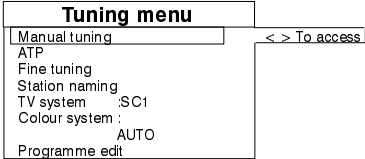
**A**  

Perform "Tuning menu access" to display the "Tuning menu".  
Press **▼▲** to move to "Manual tuning".  
Press **◀▶** to access "Manual tuning".

---

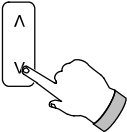
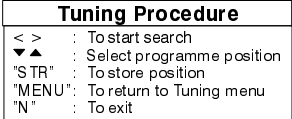
**B**  

Press **^** to select the desired programme position.

**If the local channel numbers are known proceed to Step D.**  
Position '0' should be used as the VCR channel.

---

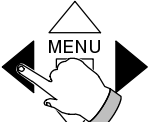
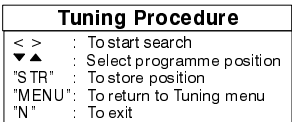
**C**  

Press **◀▶** to search for the desired channel.  
(If a cable / hyperband channel is required, continue tuning past the normal channels).  
**Now proceed to Step E.**

# Tuning Procedure

## Manual tuning operation

### Remote Control Operation

**D**

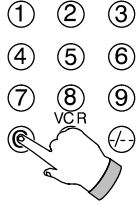

Tuning Procedure	
< >	: To start search
▼ ▲	: Select programme position
"STR"	: To store position
"MENU"	: To return to Tuning menu
"N"	: To exit

**Only use this Step if the local channel numbers are known.**

Press the 'C' key on the remote control.  
(To tune in a hyperband channel press the --/-- key)

Enter the channel number within six seconds using the numeric keys (0 – 9).

**E**

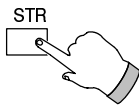

Tuning Procedure	
< >	: To start search
▼ ▲	: Select programme position
"STR"	: To store position
"MENU"	: To return to Tuning menu
"N"	: To exit

Press 'STR' to store the selected channel on the current programme position.

**Repeat steps B to E to store other channels, OR press MENU to return to 'Tuning menu', OR press 'N' to return to normal TV operation.**

### TV Operation (behind Control Panel door)

**A**

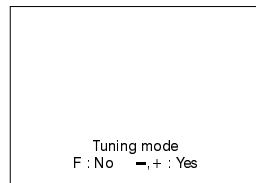
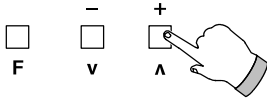

Repeatedly press the 'F' key on the front of the TV until the screen displays 'Tuning mode'.

Press - / + to enter 'Tuning mode'.

**B**



Tuning procedure (Front panel)	
- +	: To start search
"TV/AV"	: Select programme position
"STR"	: To store position
"F"	: To exit

Press 'TV / AV' to select the desired programme position.

Position '0' should be used as the VCR channel.

**C**

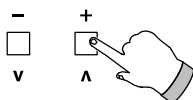

Tuning procedure (Front panel)	
- +	: To start search
"TV/AV"	: Select programme position
"STR"	: To store position
"F"	: To exit

Press - / + to search for the desired channel.  
(If a cable / hyperband channel is required, continue tuning past the normal channels).

**D**

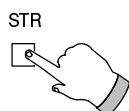

Tuning procedure (Front panel)	
- +	: To start search
"TV/AV"	: Select programme position
"STR"	: To store position
"F"	: To exit

Press 'STR' to store the selected channel on the current programme position.

**Repeat steps B to D to store other channels, OR Press 'F' key to return to normal TV operation.**

## Tuning Procedure

### Colour System Selection

The colour system is preset to AUTO, this means that when a PAL, SECAM or M.NTSC transmission is received the correct picture will automatically be displayed on screen. If desired, the colour system can be manually set to PAL, SECAM or M.NTSC as follows :

**A**

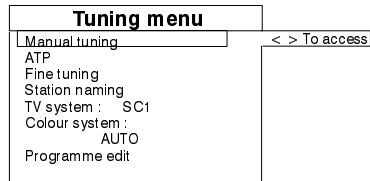
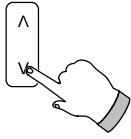

Press to select the desired programme position.

Perform "Tuning menu access" to display the "Tuning menu".

**B**

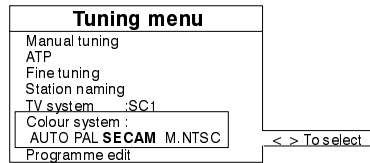
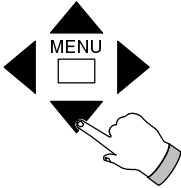

Press to move to "Colour system".  
Press to select the required Colour System :  
AUTO, PAL, SECAM or M.NTSC.

**C**

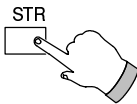

Press **STR** to store the selected Colour System for the current programme position and channel.

Press 'N' to return to normal TV operation.

### Audio Standard Selection (TV System)

When the channels are manually tuned in, it may be necessary to set the Audio Standard for each programme position / channel.

**A**

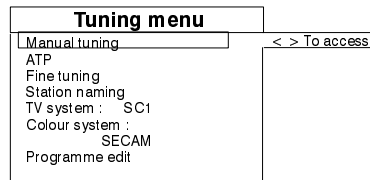
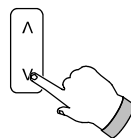

Press to select the desired programme position.

Perform "Tuning menu access" to display the "Tuning menu".

**B**

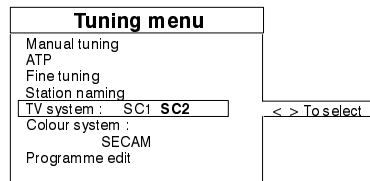
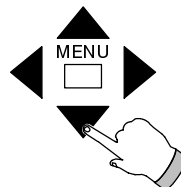

Press to move to "TV System".  
Press to select the required Audio System :  
SC1 : PAL B, G, H / SECAM B, G  
SC2 : PAL / SECAM D, K

**C**

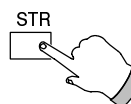

Press **STR** to store the selected Audio System for the current programme position and channel.

Press 'N' to return to normal TV operation.

# Tuning Procedure

## Station Naming Operation

Each channel may be given an individual name, this enables the channels to be remembered by name as well as programme position number.

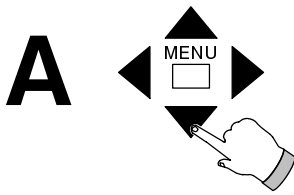

Tuning menu	
Manual tuning	
ATP	
Fine tuning	
Station naming	< > To access
TV system :SC2	
Colour system :SECAM	
Programme edit	

Perform "Tuning menu access" to display the "Tuning menu".

Press **▼▲** to move to "Station naming".  
Press **◀▶** to access "Station naming".

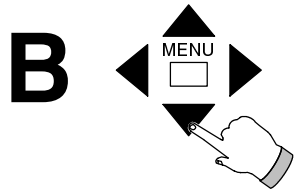

Station naming		
Prog.	Station	Ch.
01:		CH30
02:		CH56
03:		CH56
04:		CH44
05:		CH41
06:		CH49
07:		CH21
08:		CH47
09:		CH49
10:		CH44

Press **▼▲** to select the desired programme position.

Press **◀▶** to change the name.  
The first character position is selected.

Press **▼▲** to select desired character.

Press **◀▶** to move to desired character position.

**OR**

Press **MENU** to revert back to the original name.

**Repeat this Step to complete the required name.**

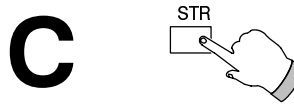

Press **STR** to store the new programme name.

**Repeat steps B and C to alter other programme names or press "N" to return to normal TV operation.**

## Programme Edit Operation

The named programme positions may be moved to another place in the programme order, deleted from the order, new ones placed into the order and locked to prevent access as required.

If you chose **E.Eu** as the country option prior to **ATP** then the **Programme Edit** menu, Step C below, will appear immediately after the **ATP** operation. This is to allow the deletion of any duplicate channels that may have been located.

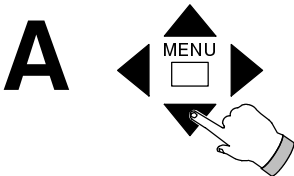

Tuning menu	
Manual tuning	
ATP	
Fine tuning	
Station naming	
TV system :SC2	
Colour system :SECAM	
Programme edit	< > To access

Perform "Tuning menu access" to display the "Tuning menu".

Press **▼▲** to move to "Programme edit".

Press **◀▶** to access "Programme edit".

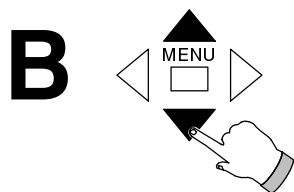

Press **▼▲** to select the desired programme position.

It is not possible to alter the VCR programme position ('0').

Press **◀▶** to select "Delete", "Add", "Move" or "Lock".

### Delete operation

Press "STR" twice to delete the selected station name and channel from the current programme position.

### Add operation

Press "STR" twice to add a blank channel in the current programme position.

To tune—in the channel refer to Manual Tuning operation on page 8.

### Move operation

Press "STR", followed by **▼▲** to select the new programme position for the current channel.

Press "STR" to end move operation.

### Lock operation

Press "STR" to lock or unlock the current programme position.

When locked, it is not possible to access or display the channel / programme position.

**Repeat Steps B and C to alter other programme positions**

**OR**

Press "N" to return to normal TV operation.

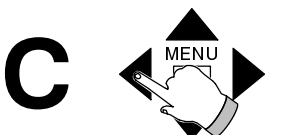

Programme edit		
Prog.	Station	Ch.
01:		CH30
02:		CH56
03:		CH56
04:		CH44
05:		CH41
06:		CH49
07:		CH21
08:		CH47
09:		CH49
10:		CH44

Programme edit options			
Delete	Add	Move	Lock

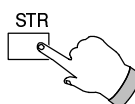

## Tuning Procedure

Certain functions will display a coloured bar on screen for a short period of time.

### Fine Tuning Operation

If a channel that has been tuned—in is slightly off station—in is slightly off station, i.e. poor picture, it may be possible to improve it by using Fine Tune to finely adjust it.

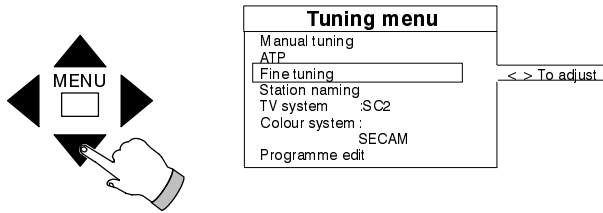

Perform “Tuning menu access” to display the “Tuning menu”.

Press  $\blacktriangledown$   $\blacktriangle$  to move to “Fine tuning”.

Press  $\blacktriangleleft$   $\blacktriangleright$  to access and alter the setting.

Press ‘STR’ to store the setting for the current channel.

Press ‘N’ to return to normal TV operation.

## Operation of Controls

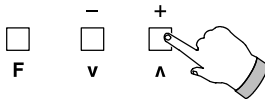

### Function select (F) (TV Operation)

Press **F** to select the required function :

Volume, Contrast, Brightness, Colour, Sharpness, Bass, Treble, Balance or Tuning mode.

Press + or – to adjust.

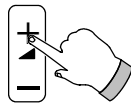

### Volume (Remote Control Operation)

Press + or – to adjust.

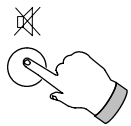

### Sound Mute

Press to mute or restore the sound.

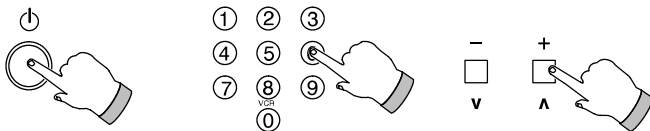

### Standby mode

Press to switch the TV. off for a period of time.

To switch back on perform one of the following :

1. Press Standby again.

2. Select a programme position from 0 – 9 on the remote control.

3. Press Programme Up / Down ( $-/\vee$   $+/\wedge$  ) on the TV.

If the TV. is in Standby mode it is not possible to switch it back on using the Power switch (front of the TV.).

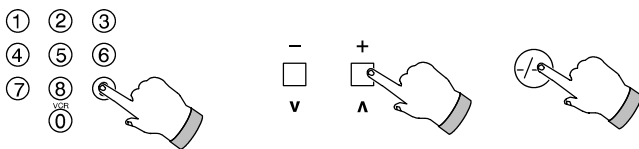

### Programme Position Selection

There are three ways to select a different programme position :

To select a programme between 0 – 9 press numeric key once.

Press up / down to change programme position by one.

To select a programme position between 10 – 99 press the  $-/-$  key followed by the numbers required.

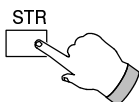

### Normalisation Store

Adjust the Volume, Bass, Treble, Balance, Colour, Tint (NTSC / M.NTSC only), Brightness, Contrast, Sharpness and Fine Tune to normal viewing levels. Press STR when the main menu or sound menu are displayed to store these levels in memory.

It is possible to store different Bass and Treble values in Music and Speech modes.

## Operation of Controls

Certain functions will display a coloured bar on screen for a short period of time.

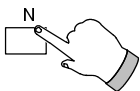

### Normalisation

Press to recall the levels previously set with Normalisation Store.

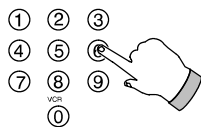

### Direct Channel Access

If the local channel numbers are known, they may be accessed directly using the following method. Press the 'C' key. (To tune in a hyperband channel press the  $-/--$  key). Press the numeric keys within six seconds. (e.g. for channel 5 press 0 and 5). The screen will display the channel.

CH=channels 2-99; H=hyper S 21-41.

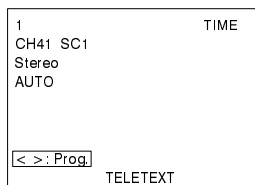
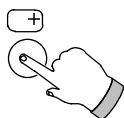

### Status / Programme Table

Press Status. The screen will display the following : Programme Position, Programme Name, Channel number, Time (If Teletext is available), Audio Systems (If available), Teletext System (If available). Press  $\blacktriangleleft\blacktriangleright$  to display the programme table for channels 1 to 31 plus VCR, 32 to 63, 64 to 95 and 96 to 99. Press Status again to remove the programme table.

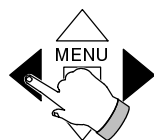

PRGNAMES	CH	PRGNAMES	CH
VCR	-	16	-
01	-	17	-
02	-	18	-
03	-	19	-
04	-	20	-
05	-	21	-
06	-	22	-
07	-	23	-
08	-	24	-
09	-	25	-
10	-	26	-
11	-	27	-
12	-	28	-
13	-	29	-
14	-	30	-
15	-	31	-

If the programme tables are not accessed and only the Status information is displayed then the programme position number will remain on screen. Press Status again to remove.

## Main Menu Operation

### Contrast

Displayed on screen as a cyan bar.

### Brightness

Displayed on screen as a white bar.

### Colour

Displayed on screen as a red bar.

### Sharpness

Displayed on screen as a green bar.

### Tint (M.NTSC / NTSC only)

Displayed on screen as a green bar.

### Sound menu

Allows access to sound controls detailed on page 14.

### Setup menu

Allows access to feature controls detailed on page 15.

### OSD language

Selects between : Polish, Czech, Romanian, Hungarian, Russia or English for the On Screen Display language.

**A**

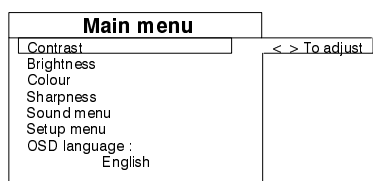
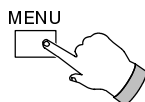

Press **MENU**. The screen will display the main menu.

**B**

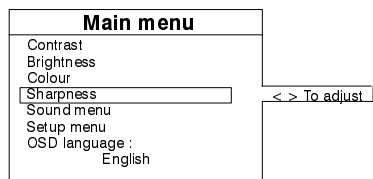
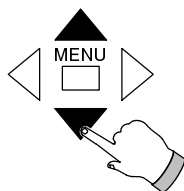

Press  $\blacktriangledown\blacktriangle$  to select the required function.

**C**

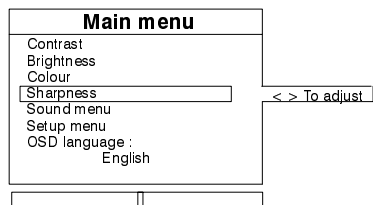
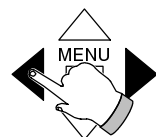

Press  $\blacktriangleleft\blacktriangleright$  to access and alter the setting.

Press 'MENU' to return to normal TV operation.

## Operation of Controls

Certain functions will display a coloured bar on screen for a short period of time.

### Sound Menu Operation

#### Bass

Adjusts the bass response up or down.  
Displayed on screen as a purple bar.

#### Treble

Adjusts the treble response up or down.  
Displayed on screen as a yellow bar.

#### Balance

Select to adjust the left / right balance between the speakers.  
Displayed on screen as a green bar.

#### Volume correction

Select to adjust the volume for individual channels, e.g. satellite channels can be set with a different volume level to terrestrial channels.  
Displayed on screen as a green bar.

#### MPX (NICAM Stereo / Normal Stereo Sound Systems)

When receiving Stereo transmissions, press to switch between NICAM / Normal Stereo and Mono sound output.

When receiving NICAM Mono / Bilingual transmissions, press to switch between NICAM Mono I / Bilingual I, NICAM Mono II / Bilingual II and mono sound output.

The sound outputs available are dependent upon what is transmitted on the received channel.

If the receiving conditions deteriorate it is advisable to switch to Mono mode.

To distinguish between NICAM and Normal Stereo reception, please consult your local Panasonic dealer for transmission information.

#### Mode

The sound can be improved during Music or Speech mode by selecting the appropriate function.

#### Ambience

A dynamic sound enhancer that gives a feeling of greater acoustic presence.

**A**

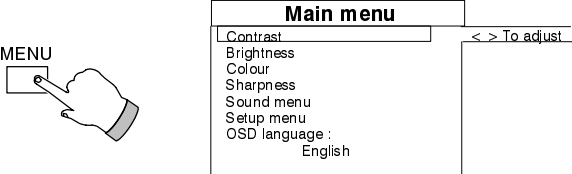

Press **MENU**.  
The screen will display the main menu.

---

**B**

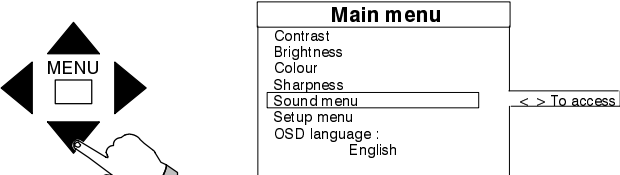

Press **▼▲** to move to "Sound menu".  
Press **◀▶** to access "Sound menu".

---

**C**

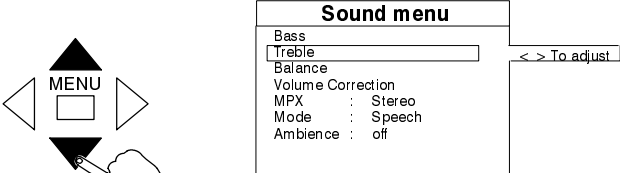

Press **▼▲** to select the required function.

---

**D**

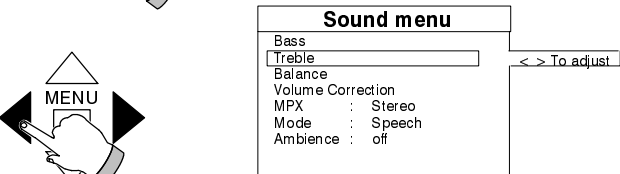

Press **◀▶** to select or adjust the setting.  
**Press 'N' to return to normal TV operation.**

### Important Information

The received channels sound may deteriorate below an acceptable listening level, if this occurs it is advisable to perform the following :

1. Perform steps A, B and C, as detailed above, selecting MPX in step C.
2. Press **◀▶** to switch the sound mode to Mono.
3. Press **'N'** to return to normal TV operation.

When the receiving conditions improve, the available MPX options (e.g. Stereo or Mono) will be selectable again, if so perform the following :

1. Perform steps A, B and C, as detailed above, selecting MPX in step C.
2. Press **◀▶** to select between the available options (e.g. Stereo or Mono).
3. Press **'N'** to return to normal TV operation.

# Features Operation

Certain functions will display a coloured bar on screen for a short period of time.

## Setup Menu Operation

### AI (Artificial Intelligence)

As the TV video signal is processed for immediate reception, "Brightness", "Contrast", "Shade of Colour", etc. are automatically adjusted to the optimum conditions.

Each frame is finely and automatically adjusted to compensate for the picture's characteristics thereby achieving contrast with optimum field of depth, and vivid colour tones.

### Noise-R (Picture Noise Reduction)

Reduces the picture noise i.e. interference.

### Aspect (Picture Format)

When receiving a 16:9 format signal select to obtain the correct picture height on screen.

16 : 9 : Wide screen  
4 : 3 : Normal

Aspect 4 : 3



Aspect 16 : 9



A correct 16:9 picture format is only possible when a 16:9 signal is received through the AV 21 pin terminals. It is possible to switch a normal 4:3 signal into 16:9 mode, but this is for effect only and does not accurately represent the 16:9 picture format. Picture format cannot be changed whilst in Teletext mode.

### Off Timer

This enables you to select the time after which the TV switches off to the Standby mode, 30, 60 or 90 minutes.

### Tuning menu

Allows access to the tuning-in menu. Refer to tuning procedure starting on page 7.

**A**

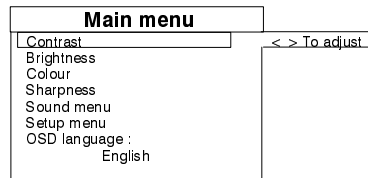
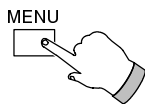

Press **MENU**.  
The screen will display the main menu.

**B**

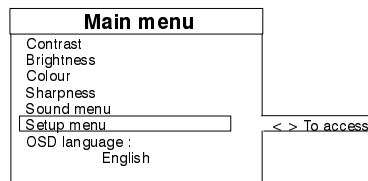
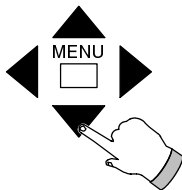

Press **▼▲** to move to "Setup menu".  
Press **◀▶** to access "Setup menu".

**C**

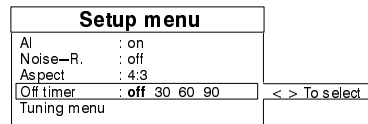
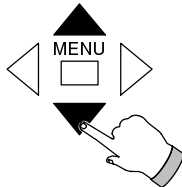

Press **▼▲** to select the required function.  
AI, Noise-R, Aspect, Off timer, Tuning menu.

**D**

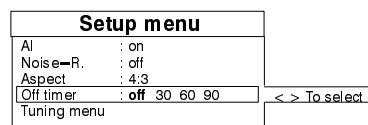
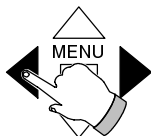

Press **◀▶** to access or alter the setting.  
Press '**N**' to return to normal TV operation.



## TV / AV Selection

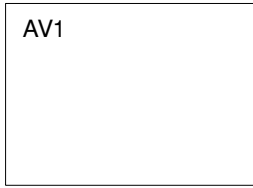
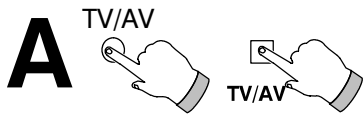

Press **TV / AV** to switch to Audio / Video mode.

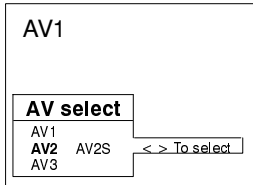
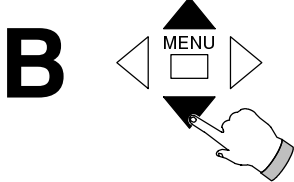

Press **▼ ▲** to select desired AV source :– AV1, AV2 or AV3.

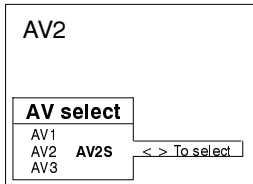
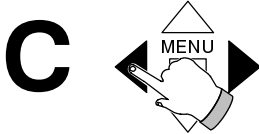

**Only use this Step when AV2 is selected.**

Press **◀ ▶** to select between AV2 or AV2S.

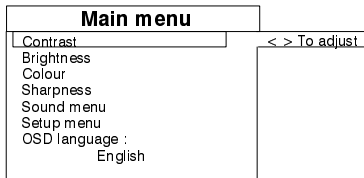

**Only use Steps D to F if the transmission standard is to be set.**

Press **MENU**.  
The screen will display the main menu.

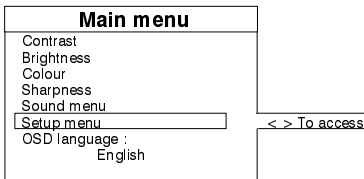
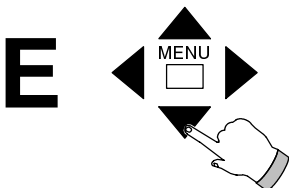

Press **▼ ▲** to move to “**Setup menu**”.  
Press **◀ ▶** to access “**Setup menu**”.

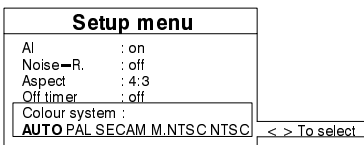
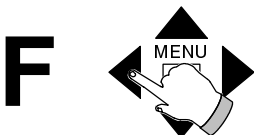

Press **▼ ▲** to move to “**Colour system**”.  
Press **◀ ▶** to select desired colour system :– AUTO, PAL, SECAM, M, NTSC or NTSC.

Press “**N**” to remove “**Setup menu**”.

If AUTO is selected, the TV will switch automatically to the correct transmission standard.

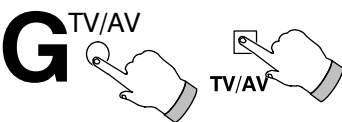

Press **TV / AV** to return to normal TV operation.

- Examples of Audio / Video connections are shown on pages 20 and 21.
- AV1 and AV2 are capable of switching to AV operation automatically if the equipment connected provides a switching signal. In this condition the display will show EC1 or EC2 and it is possible to change the programme position of the TV without changing the displayed picture.  
To return to TV operation press the TV / AV key.

## VCR Operation

The Remote Control is capable of operating some functions of selected Panasonic VCRs, please consult your dealer for details. Some VCR have different functions, so to ensure compatibility, please refer to the VCR's instruction book.

If any difficulty is encountered when using this remote control with Panasonic videorecorders please check the operation of the video recorder with the operating switch set at position one and again with the switch set at position two.

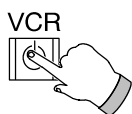
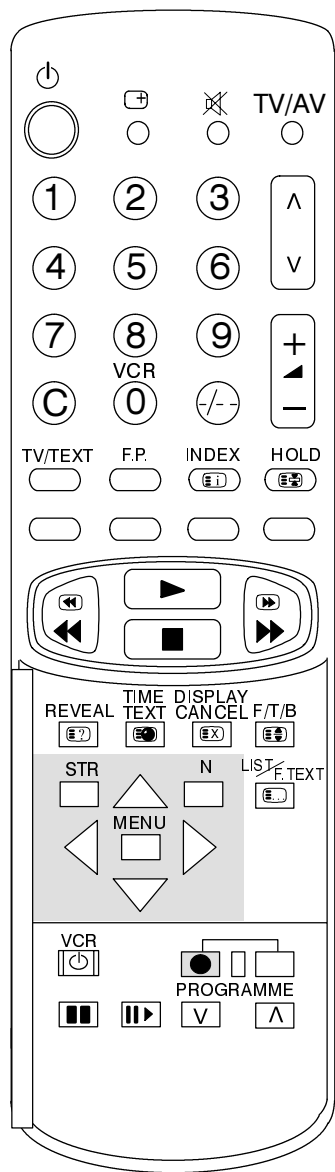

### Standby

Press to switch the VCR to standby mode. Press again to switch back on.

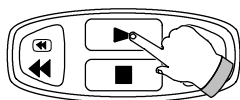

### Play

Press to playback the tape.

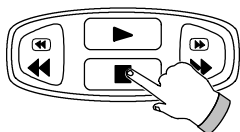

### Stop

Press to stop the tape.

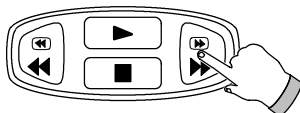

### Fast Forward / Cue

Press to fast forward the tape. In Play mode, press to view the picture rapidly forward.

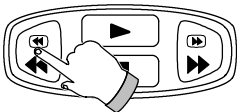

### Rewind / Review

Press to rewind the tape. In Play mode, press to view the picture in reverse rapidly.



### Pause / Still

Press in playback mode, the picture will pause.



### Still Advance

While in PAUSE / STILL mode, press to advance the picture one frame at a time.



### Programme Up / Down

Press to increase or decrease the VCR programme position by one.

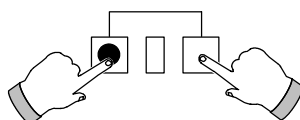

### Record

Press these together to record.

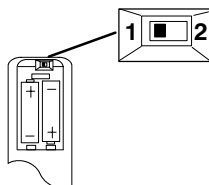

### Operating Switch

If any difficulty is encountered when using this remote control with Panasonic video tape recorders please check the operation of the video recorder with the operating switch set at position one and again with the switch set at position two.

## Teletext Operation

- Teletext features may vary depending on the Broadcasting Companies and is only available if the channel selected is transmitting Teletext.
- This TV set is capable of receiving German TOP Teletext transmissions, it will automatically switch to them if they are being received. This will be indicated in the display area at the bottom of the screen.
- Pressing the **MENU** key whilst in Teletext operation will display the contrast function with a cyan bar, press ◀ ▶ to alter the setting as required.
- When in teletext mode, the volume may still be altered to the desired listening level.

### What is LIST mode?

In LIST mode, four differently coloured page numbers are situated at the bottom of the screen. Each of these numbers can be altered and stored in the TV's memory.

### What is FASTEXT?

In FASTEXT mode, four differently coloured subjects are situated at the bottom of the display. To access more information about one of these subjects, press the appropriately coloured button. This facility enables fast access to information of the subjects shown.

### What is TOP Teletext?

TOP stands for TABLE OF PAGES or 'Teletext without problems'

TOP Teletext is a new development to make the task of selecting the desired Teletext pages easier and shorter. In fact page access time is instantaneous, just press the button and the page appears.

### How does it work?

TOP uses the four coloured keys, Red, Green, Yellow and Blue to select the following information.

- The Red key will select the next available page DOWN.
- The Green key will select the next available page UP.
- The Yellow key selects pages within a group, each time the Yellow key is pressed the topic within the group will change, for example you could change from an Economic topic to a CULTURAL topic by using this key. With the Red and Green keys selection of the next available pages DOWN and UP is possible within the CULTURAL topic.
- A larger jump from group to block is possible by use of the Blue key, this could be a SPORT topic for example. Within this SPORT topic it is possible to select different groups such as Tennis, Football, Baseball etc, using the Red and Green keys the next available pages DOWN and UP can be selected.

### What are the advantages?

- Page selection at the touch of a single key.
- Easy to use step-by-step selection of the topical subject.
- Reduction of waiting time.
- If a non-existent page number is entered, a question mark will appear at the bottom of the screen.
- Page status line at bottom of screen so you always know which key will take you to the desired information.

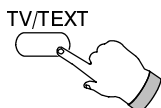

### TV / Teletext mode

Press the **TV/TEXT** key.  
The screen will display the Teletext page.  
Press again when you wish to return to TV. mode.

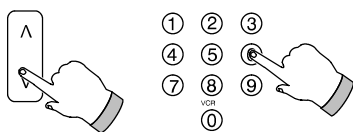

### Page Selection

Pages can be selected in two ways :  
a. Press the Up / Down keys to increase or decrease the page number by one.  
b. By entering the page number, using 0 –9 on the remote control.

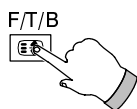

### Full / Top / Bottom

Press to expand the TOP half of the page.  
Press again to expand the BOTTOM half.  
Press again to return to normal (FULL) size.



### Reveal

Press to reveal hidden words e.g. quiz page answers.  
Press again to hide.

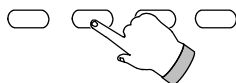

### Red / Green / Yellow / Blue keys

In TOP or FASTEXT mode these correspond to the differently coloured subjects.  
In LIST mode they correspond to the differently coloured page numbers.

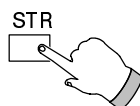

### List Store

In LIST mode the four page numbers can be altered for channel positions 1 – 25 only.  
To do this, press one of the coloured keys and enter the new page number.  
Press and hold **STR**, the page numbers will change colour.

It is not possible to change the programme position when in News flash, Update or Sub Coded Page Access operation.

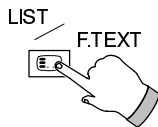

### List / F.text (List / Top)

#### When in List / Top operation

Press to change from TOP mode to LIST operation and vice versa.

#### When in List / Fastext operation

Press to change from FASTEXT mode to LIST mode and vice versa.

In FASTEXT mode four differently coloured subjects are displayed at the bottom of the page. Press the appropriate coloured key to access more information about one of these subjects.

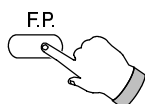

### Favourite Page (F.P.)

Stores a favourite page in memory for instant recall. To store such a page, the TV must be in LIST mode, and the programme position must be from 1 – 25. Press the **BLUE** key, select the page number, then press **STR**. The page number is now stored. Press **F.P.** to recall this page.

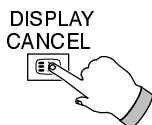

### Display Cancel

Press **DISPLAY CANCEL** to view the TV picture whilst searching for a Teletext page. When found, the screen will display the page number at the top left. Press **DISPLAY CANCEL** to view the page. Press **TV / TEXT** to return to normal TV operation.

#### News Flash

When a news flash page has been selected, press **DISPLAY CANCEL** to view the TV picture, when an update is received, it will be displayed on screen. Press **DISPLAY CANCEL** to remove updated news. Press **TV / TEXT** to return to normal TV operation.

#### Update

Press **DISPLAY CANCEL** to see the update of information on certain pages. When an update is received, the page number will be displayed at the top left of the screen. Press **DISPLAY CANCEL** to view the page. Press **TV / TEXT** to return to normal TV operation.

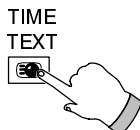

### Sub Coded Page Access

When teletext information exceeds more than one page, it may take some time for the automatic changing of the sub pages to reach the sub page you require. It is possible to enter your required sub page and continue watching the normal programme until the correct sub page is found.

Select the required page number using keys 0 – 9.

Press **TIME TEXT**, \*\*\*\* will be displayed (top right of the screen).

Enter desired sub page number before the \*\*\*\* disappears.  
To select page 6 enter 0, 0, 0 and 6.

If in LIST mode, a 'T' will appear in the current box at the bottom.

Press **DISPLAY CANCEL** to view a normal TV programme.

When the page is available, press **DISPLAY CANCEL** to view the page. To clear the page perform one of the following :

- Select a new page number.
- Press **TV/TEXT** to return to normal TV operation.

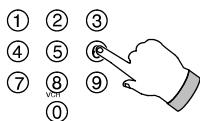

### Index

#### When in TOP operation

Press **INDEX** to display the PANASONIC INDEX Directory

Press **RED / GREEN** to move the cursor UP / DOWN.

Press **YELLOW** to move to next directory page.

Press **BLUE** to view the selected subject.

Press **INDEX** key to return to the previously selected page or press **RESET** to return to main index.

#### When in FASTEXT operation

Press **INDEX** to return to the main index page.



## Audio / Video (AV) Connections

### ■ Via the AV1 / AV2 21 Pin (SCART) terminals

Playback or Recording Equipment (VHS or S-VHS VCR)  
(Not Supplied)

- To connect a VHS VCR use the AV1 21 pin terminal.
- To connect an S-VHS VCR use the AV2 S-VHS 21 pin terminal.

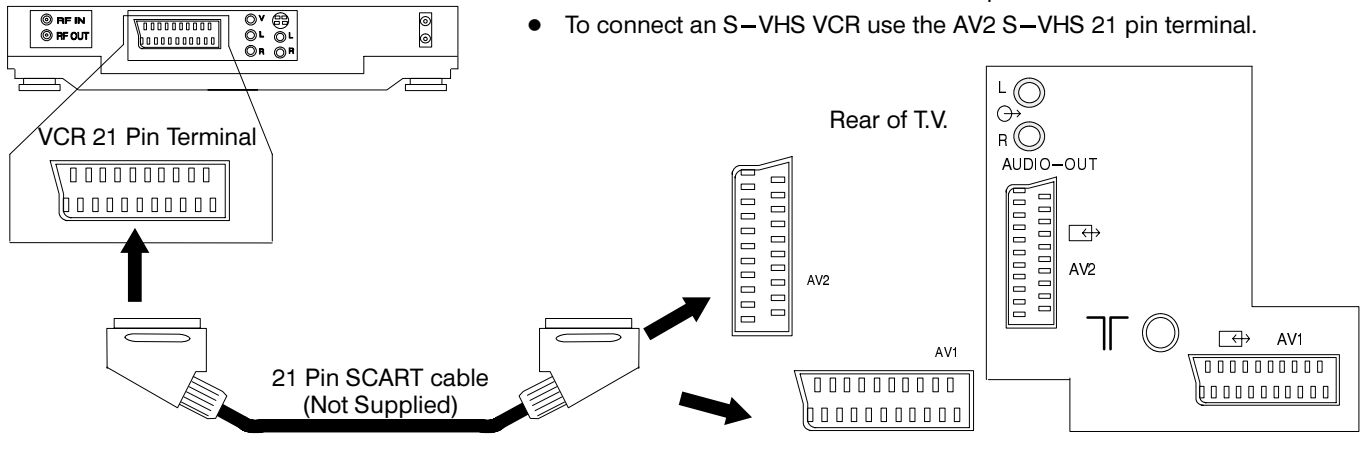

### ■ Via the front AV3 Video and Audio RCA

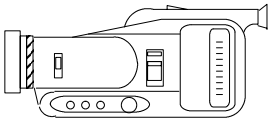

VCR or Camera  
Playback Equipment (VHS)  
(Not Supplied)

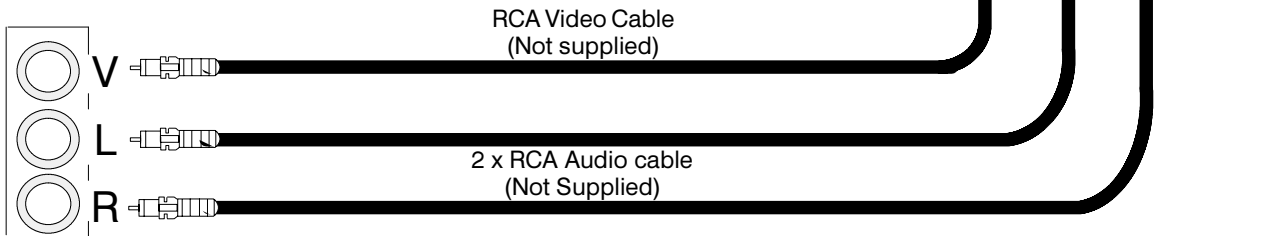

### ■ SCART Terminal Information

Socket Earth	21	20	CVBS in (video)
CVBS out (video)	19	18	RGB status earth
CVBS earth	17	16	Status RGB
Red in	15	14	Ground
Red earth	13	12	--
Green in	11	10	--
Green earth	9	8	Status CVBS
Blue in	7	6	Audio in (L)
Blue earth	5	4	Audio earth
Audio out (L)	3	2	Audio in (R)
Audio out (R)	1		

- The AV2 21 pin terminal has the following differences from the AV1 21 pin terminal :-  
PIN 7 - No connection      PIN 11 - No connection      PIN 15 - S.C - In  
PIN 16 - No connection      PIN 20 - CVBS in (S-Y in)

Pins 15 and 20 are dependent on AV2 S-VHS / VIDEO switching.

## Audio / Video (AV) Connections

### ■ Via the rear RCA Audio Out terminals

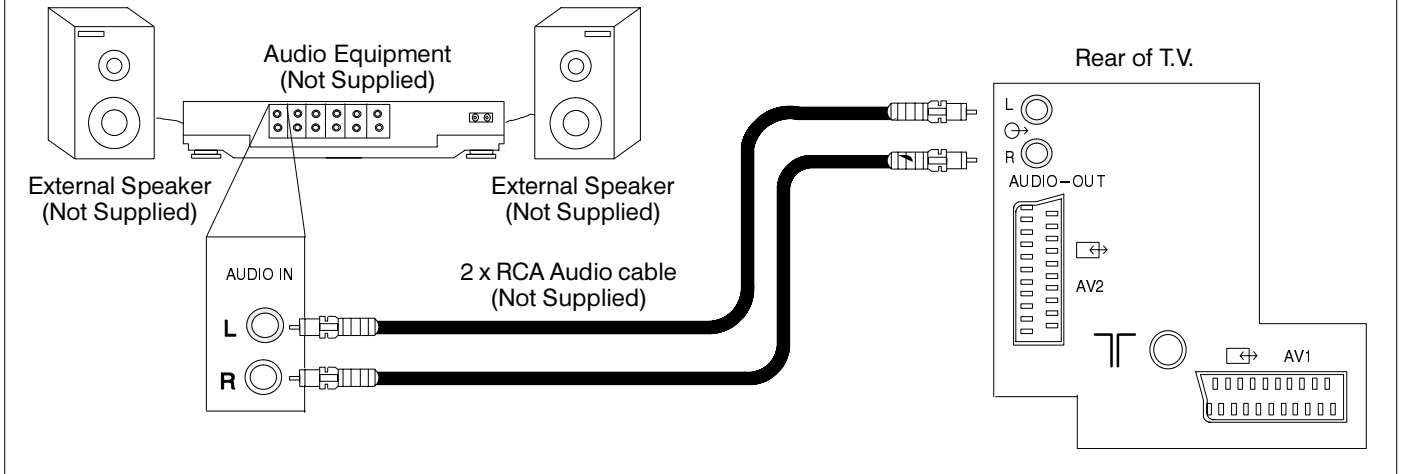

### ■ Connection of Stereo Headphones

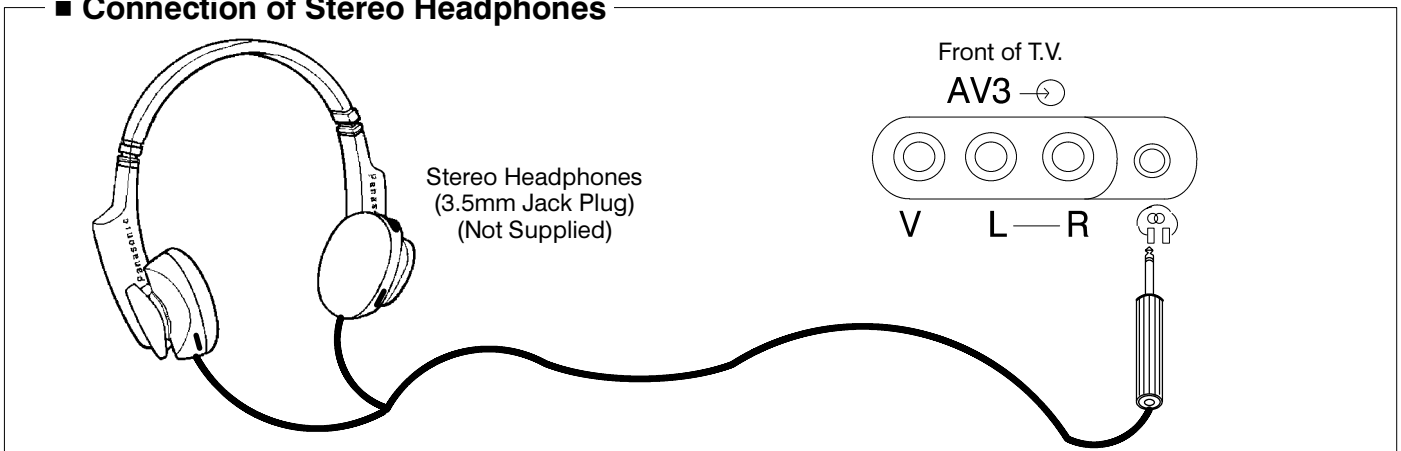

- Cables shown are not supplied with this T.V. set.
- Do not connect a computer with TTL output (5V) to this set.

## Trouble–shooting

Before calling for service, make a few simple checks as follows :

Symptoms		Checks
Picture	Sound	
Snowy Picture or Multiple Images	Noisy Sound or Normal Sound	Aerial location, direction or connection
Interference	Noisy Sound	Electrical appliances, Vehicles, Fluorescent lights
Normal Picture	Noisy or No Sound	Volume level, Sound muted Check correct Audio Standard selected
No Picture	No Sound	Not plugged into A.C. outlet, Not switched on Picture / Sound controls set at minimum levels
No Colour	Normal Sound	Colour controls set at minimum levels
Scrambled	Normal or Weak Sound	Retune Channel(s)

## Specifications

		<b>TX-28LD2P</b>
<b>Power Source</b>		220 – 240V 50Hz C.A.
<b>Power consumption</b>		121W
<b>Standby Power consumption</b> 		1W
<b>Picture Tube visible diagonal</b>		66cm
<b>Audio Output</b>		2 x 15W Music
<b>Dimensions</b>	H W D	582 mm 752 mm 472 mm
<b>Weight (Kg)</b>		32
<b>Receiving Systems/ Band name</b>		<b>PAL B, PAL G, PAL H, PAL-60, SECAM B, SECAM G.</b> VHF E2 – E12                      VHF H1 – H2 (ITALY) VHF A – H (ITALY)              UHF E21 – E69 CATV (S01 – S05)                CATV S1 – S10 (M1 – M10) CATV S11 – S20 (U1 – U10)    CATV S21 – S41 (Hyperband) <b>PAL D, PAL K, SECAM D, SECAM K.</b> VHF R1 – R2                        VHF R3 – R5 VHF R6 – R12                      UHF E21 – E69 <b>M.NTSC</b> Playback from NTSC 4.43 MHz Videorecorders (VCR) <b>NTSC (AV input only)</b> Playback from NTSC Videorecorders (VCR)
<b>Aerial – Rear</b>		UHF / VHF
<b>Headphones – Front</b>		3,5mm
<b>AV – Rear</b>		<b>AV1</b> – 21 pin terminal – Audio / Video in / out, RGB in. <b>AV2</b> – 21 pin terminal – Audio / Video in / out, S–Video in. 2 x RCA Audio Monitor Out
<b>AV – Front</b>		<b>AV3</b> – 2 x RCA Audio in, 1 x RCA Video in

Specifications are subject to change without notice. Weight and dimensions shown are approximate.





